

# THE USE OF 3D GEOMETRIC MODELS IN SPECIAL PURPOSE KNITWEAR DESIGN AND PREDICTING OF ITS PROPERTIES

Svitlana Bobrova, Tetiana Ielina, Nataliia Beskin, Victoria Bezsmertna  
and Liudmyla Halavska

*Kyiv National University of Technologies and Design, Nemirovich-Danchenko Str. 2, 01011 Kyiv, Ukraine*  
[bobrova.sy@knuvd.com.ua](mailto:bobrova.sy@knuvd.com.ua), [yelina.tv@knuvd.com.ua](mailto:yelina.tv@knuvd.com.ua), [natalibeskin@gmail.com](mailto:natalibeskin@gmail.com), [vikkyloria2610@gmail.com](mailto:vikkyloria2610@gmail.com)

**Abstract:** *The article deals with the issues of predicting special purpose knitted fabrics properties. We suggest solving this problem by designing a 3D geometric model of a knitwear structure. The proposed technique has been used to design a 3D model of a double-layered knitwear structure, which is used for ballistic protective clothing manufacturing.*

**Keywords:** *3D modeling, weft-knitting, loop length, B-spline, knitted structure, yarn central line geometry, special purpose knitted fabrics, personal protective equipment, armor protection.*

## 1 INTRODUCTION

The special purpose knitted fabric for personal protective equipment has to meet a number of requirements for physical, mechanical, hygienic and other properties, as it is subjected to various types of force application during wear. It is made of high strength threads and it is used to protect users against the following risks: effects of small arms projectiles, effects of shrapnel from explosives, effects of stabbing and cutting weapons. Clarifying the relationship between threads characteristics and their configurations in a knitted structure on the one hand and protective properties of fabrics on the other hand is a difficult task which demands a special approach and accuracy [1, 2].

Designing of a special purpose knitted fabric is concerned with choosing the optimal physical-mechanical and geometric characteristics.

The invention of the universal computer simulation systems has solved the problem of optimizing the properties of personal protection based on an analysis of raw materials properties. Such systems perform the analysis of physic-mechanical properties under investigation on the basis of their 3D geometric models. Therefore, one of the crucial points for a simulation research of the reliability of individual armor protection products that are made of high tensile strength knitwear is the adequacy of the mathematical description of its structure.

It is known that the structure of knitwear is determined in accordance with the size and configuration of the elements of the fabrics or a knitwear product itself, relative position of the knitting elements and the way these elements interact with each other. The automation of a knit structure design provides an opportunity to use

an object model which reflects some properties of the object, particularly significant to the researcher. Thus there is no need to manufacture a sample. The models are called mathematic, when formalized by the means of mathematical tools and language. In other words, the mathematical models show the interrelationships among the parameters of the object and make it possible to estimate the outcome of the project decisions. The important benefit of using the described models is the opportunity to obtain information about the object without conducting the natural experiments. People have created and been improving the model of the knitting loop for approximately a century now. By this time a number of research studies have been done on geometric description of the knitwear structure and defining the interrelationships among its most significant properties. Different ways to define these interrelationships were provided in works by E. Tompkins [3], J. Chamberlain [4], F. T. Peirce [5], G.A.V. Leaf and A. Glaskin [6], D. Munden [7], Vekasi [8], A.S. Dalidovich [9], Korlinski [10], Morroka & Matsumoto [11], V.R. Krutikova [12], Nutting & Leaf [13], Postle [14], Whitney & Epting [15], Popper [16], Postle & Munden [17], Shanahan & Postle [18], Hepworth & Hepworth & Leaf [19], A.V. Truevtsev [20], and others.

Computer models of the knitwear structure are based on one or several theoretical models (geometric, energetic and/or mechanical). Also a ready-made prototype can be digitized. A theoretical base is required for building special programs which allow to recreate the knitted yarn geometry in the 3D modeling environment. The choice of the base is determined by the purpose of a CAD under construction. Different methods of building 3D models of fabric structure are described in works [21-25] and others. Such models

provide good topological yarn alignment in a model and therefore in a sample and also ensure a high level of visual resemblance. The following works [26-29] give a spotlight on fiber length control within elements of the structure for a model and its prototype. It is known that BFS (Backface Signature) depth deformation of knitted fabrics is connected to the redistribution of the yarn in the knitwear structure. Therefore, the model which possesses exactly the same shape and loop length as the prototype is crucial for assessing the reliability of armor protection.

## 2 LOOP CHARACTERISTIC POINTS POSITIONING

During knitting process, a part of yarn takes a shape of a loop, if pulled through a lower fixative element (in most cases it is the head of the previous loop) and thrown over an overhead fixative element (the feet of the next loop) [26]. In Figure 1 a zone of fixation 1 is shown. It is the overhead one for the loop 2 and the lower one for the loop 3. Each zone of fixation contains two zones of the contact of threads (interlacing zones) 4 and 5 (see Figure 1). In turn, each zone of contact includes two points of contact 6, 7, 8, 9. Yarn interaction forces, as we assume, are applied at these points.

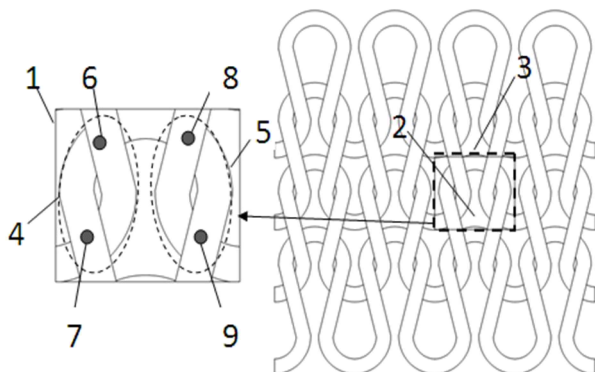

**Figure 1** Positioning of contact points in a plain-knitted structure

Regardless which mathematical objects are used for the representation of the yarn configuration in a knitted structure, when modeling in 3D environment they must provide passing its central line through the characteristic points of the loop. Under characteristic points we mean points lying directly on the yarn central line, their location in 3D space has to be defined by using traditional ideas concerning shape of a loop. In Figure 2 such points are:

- $K$  – the upper point of the loop head;
- $B$  – the point of connection of the needle loop and the loop arm;
- $T$  – the central point of the loop arm;

$S$  – as the point of connection of the loop arm and the sinker loop;

$W$  – the lowest point of the sinker loop.

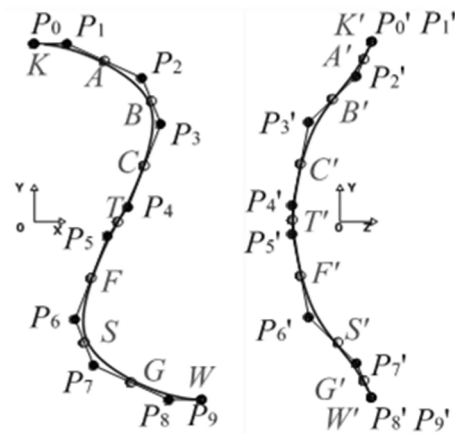

**Figure 2** Orthogonal views of the yarn central line of a loop half

Requirements for the curves that can be used for representation of the yarn central line in 3D-modeling systems are given below [29]:

- the spatial curve equation must provide its passing through the characteristic points;
- curvature of line segments between characteristic points must be "changeable";
- length of this spatial curve must correspond to loop length of a real knitted fabric having the corresponding basic structure parameters;
- connections of curves representing the central lines of nearby structure elements of the knitted course in model must be smooth.

It is fundamentally important for a spline to pass through defining points and to make formulas of passing from coordinates of characteristic points to curve equation between them easy to process within our programs. In the paper [29] Catmull-Rom-curves and second-order Bézier curves were considered as possible basis for yarn axial line representation. In our view, quadratic Bézier curves suit the best. But they describe curve between only two neighboring points. Set of these curves could be accepted, however generation of smoothly-joined Bézier curves equation for such number of segments is a very complex task. Since B-spline equation is based on the same functions as Bézier curves, while being more convenient for machine description of continuous, repeatedly bent curve, we chose B-splines.

Consider the task to create the plain-knitted structure 3D model. For an existing sample of a knitted structure, data values of  $l$ ,  $w$ ,  $c$ ,  $t$ ,  $d$ , where  $l$  is the loop length [mm],  $w$  - wale-spacing [mm],  $c$  - course-spacing [mm],  $t$  - thickness of the knitted fabric [mm],  $d$  - yarn diameter [mm], can be defined

experimentally or by formulas [9]. In a model, built on recorded data of  $w$ ,  $c$ ,  $t$ ,  $d$ , the central line of a virtual yarn will pass through the characteristic points. However, through the above mentioned points in space it is possible to conduct a great number of curves with different curvature. The lengths of lines with different values of curvature will differ, respectively. Including a variable, which influences some control vertices position, to the calculation algorithm allows to regulate the length of a virtual loop and line curvature indirectly. Such an independent variable is the angle  $\gamma$  (Figure 3).

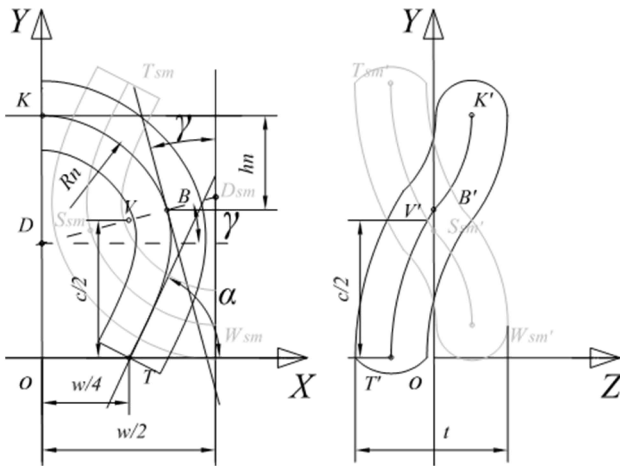

**Figure 3** Positioning of characteristic points of a loop in its upper-right part

The fabric plane assumed to contain points  $B$  and  $S$  and coincide with plane  $OXY$  for a coordinate system, in which the axis  $OX$  is directed along courses and divides a loop into wale direction symmetrically, and  $OY$  axis is oriented in the wale direction and form the line of symmetry of the loop in the course direction. In the upper-right part of the loop the characteristic points  $K$ ,  $B$ ,  $T$  with coordinates  $(X_K; Y_K; Z_K)$ ,  $(X_B; Y_B; Z_B)$ ,  $(X_T; Y_T; Z_T)$  are situated on the yarn central line as shown in Figure 3. As the loop was assumed to be symmetrical relatively to its central axis, the point coordinates of  $T$  are:

$$X_T = \frac{w}{4}; \quad Y_T = 0; \quad Z_T = -\frac{t-d}{2} \quad (1)$$

In the yarn interlacing zones (4 and 5 in Figure 1) the mutual location of yarns central lines is assumed depending only on the yarn diameter  $d$ . Also the projection of the needle loop on the  $XY$  plane is assumed to be a circular arc with the radius  $R_n$  (see Figure 3):

$$X_B = \frac{w}{4} + \frac{d}{2} \cdot \cos \gamma; \quad Y_B = \frac{c}{2} + \frac{d}{2} \cdot \sin \gamma; \quad Z_B = 0 \quad (2)$$

$$R_n = X_B / \cos \gamma \quad (3)$$

$$h_n = R_n \cdot (1 - \sin \gamma) \quad (4)$$

$$X_K = 0; \quad Y_K = \frac{c}{2} + h_n; \quad Z_K = \frac{t-d}{2} \quad (5)$$

The point  $D$  (Figure 3) is the center of the circular arc, which represents the needle loop, and  $D_{sm}$  is the center of the sinker loop of an adjacent loop in projection on the fabric plane. Taking into account the location of the selected coordinates system we can define the coordinates of points  $D$  and  $D_{sm}$  by the following formula:

$$X_D = 0; \quad Y_D = Y_B - R_n \cdot \sin \gamma \quad (6)$$

$$X_{D_{sm}} = \frac{w}{2}; \quad Y_{D_{sm}} = Y_D + \frac{w}{2} \cdot \operatorname{tg} \gamma \quad (7)$$

Then the angle of the loop arm inclination in the fabric plane  $\alpha$  will be calculated by the formula:

$$\alpha = \operatorname{arctg} \left( \frac{Y_K + Y_{D_{sm}}}{w/2} \right) \quad (8)$$

### 3 B-SPLINE CONTROL VERTICES POSITIONING

To record a B-spline equation it is necessary to pass from the coordinates of points belonging directly to the yarn central line (characteristic points), to the coordinates of points that determine directions of tangents built to the curve at its characteristic points. In Figure 4 such points are  $P_0, P_1, P_2, P_3$  and  $P_4$ . To define a space location of tangents intersection points, it is easier to begin with operating of their projections on the orthogonal planes [26].

On projection on the planes  $XOY$  and  $XOZ$  one fourth part of the yarn axial line is located between straight lines 1, 2, and 3 as shown in Figure 4. The line 1 is the tangent to the needle loop at its top point. It passes through the point  $K$  being parallel to the axis  $OX$  as well as to the plane  $XOY$ . Line 2 is the tangent at point  $B$  therefore it passes through the point  $B$  and forms an angle  $\gamma$  with a straight line, parallel to the  $OY$  axis as can be seen in Figure 3. Angle of the line 3 inclination can be found on formula (8). The intersection of lines 1 and 2 is denoted by  $t_{12}(X_{t12}; Y_{t12}; Z_{t12})$ , and intersection of lines 2 and 3 by  $t_{23}(X_{t23}; Y_{t23}; Z_{t23})$ . In the  $XOY$  plane at the point  $B$  two 2D curves (projections of 3D curve segments) unite. They can be described as two B-splines, or two quadratic Bezier curves. Each of them is defined by three points. For the segment  $KB$  they are points  $K(X_K, Y_K)$ ,  $t_{12}(X_{t12}, Y_{t12})$ , and  $B(X_B, Y_B)$ . For segment  $BT$  they are points  $B(X_B, Y_B)$ ,  $t_{23}(X_{t23}, Y_{t23})$ , and  $T(X_T, Y_T)$ . Tangents to these curves (curve segments) at the point  $B$  coincide.

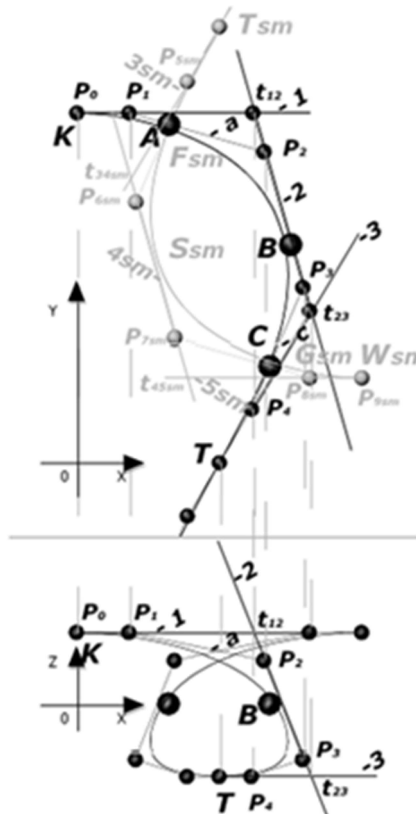

**Figure 4** Central line of a yarn segment of an interlacement zone

In a general case the equation of a straight line can be written in as:

$$y = kx + a, \quad (9)$$

where  $k$  is the slope of the line,  $a$  – ordinate of the point of intersection of the straight line and the axis OY.

The slopes of tangents 1, 2, 3 will be represented by  $k_1$ ,  $k_2$ , and  $k_3$ , respectively and  $a_1$ ,  $a_2$ ,  $a_3$  will represent the intersection point with the axis OY. Thus we can apply the following formula:

$$\begin{aligned} k_1 &= 0; & a_1 &= Y_K \\ k_2 &= \operatorname{tg}\left(\frac{\pi}{2} + \gamma\right); & a_2 &= Y_B - k_2 \cdot X_B \end{aligned} \quad (10)$$

where  $X_B$ ,  $Y_B$  - are coordinates of point B, defined on formulas (2).

Coordinates of the intersection point of lines 1 and 2 are:

$$X_{t12} = \frac{a_2 - a_1}{k_1 - k_2} \quad Y_{t12} = Y_K \quad (11)$$

Using the same approach as was employed with the intersection point of straight lines 1 and 2, we find the intersection point of lines 2 and 3, taking into account that slope of the line 3 is known from formula (8).

The points of contact between A and C belong to the curve segments KB and BT respectively. The easiest

way to find their exact location is to use an iterative method in a program environment. Thus, we have coordinates of points A ( $X_A$ ;  $Y_A$ ) and C ( $X_C$ ;  $Y_C$ ), and values of parameters of  $u_a$  and  $u_c$  in these points. Consequently, slopes of tangents to the yarn axial line at points A and C can be defined by means of differentiation of the B-splines equations.

The point  $P_1$  is located on crossing of tangent to the spline in the point A (line a in Figure 4) with the line 1.  $P_2$  is on crossing of the line a with the line 2.  $P_3$  is on crossing of the line c with the line 2, and  $P_4$  - with the line 3. The coordinates of the point  $P_0$  coincide with the coordinates of K, which were found before and coordinates of points  $P_5 - P_9$  can be defined by using the rules of symmetry.

#### 4 THREAD CONFIGURATION IN THE DOUBLE-LAYERED KNITWEAR STRUCTURE

Double-layered knitwear is commonly used for the armor protection manufacturing. The graphs are shown in Figure 5. The center line equations of the thread on different interlacement zones are compiled on the following considerations. In the double-layer knitwear [30] structure four types of threads are formed with different configurations: LC1, LC2, LR1, LR2 (Figure 5).

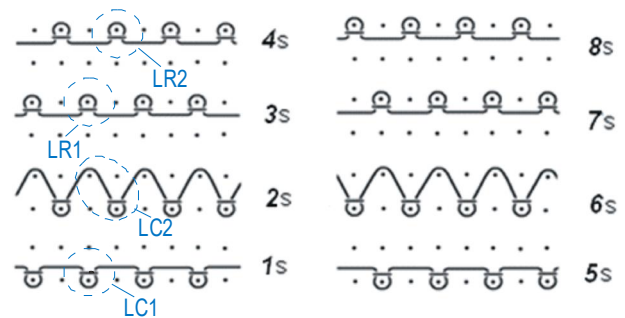

**Figure 5** The graphs of double-layered weft knitted structures

For a mathematical description we isolate the repetitive part of the curve in each of these sections, coping of which can be used to recreate the entire section. Sections of the LC1 thread are formed on needles of the cylinder systems 1 and 5 and represent the loops of the single cross miss. Sections of the LC2 thread are also formed on needles of the cylinder systems 2 and 6 as loops with tucks. On needles of the systems 3 and 7 sections of the LR1 thread are formed as loops of the cross miss, on which the loops that are formed in 8 system and tucks of thread LR2 section are dropped. In systems 4 and 8, sections of the LR2 thread are formed as loops of the cross miss, on which loops that are formed in system 7 are dropped.

**Table 1** Initial knitting process data for knitted fabrics

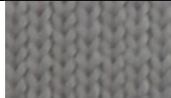
Knitting structure		Raw materials in knitting system	Linear density [tex]
double-layer interlock-based		1s, 2s, 5s, 6s – polyamide thread	29
		3s, 4s, 7s, 8s – UHMWPE fiber	44

A mathematical description of the LC1 and LR2 section configurations can be constructed by the algorithm for calculating the coordinates of the reference points, which we have developed for the single plain. It was developed in such way that the point P9 was sharpened along the course. For the cross miss loop it will be  $x_9=A$  instead of  $x_9=A/2$ . Consider the configuration of the thread LC2 section (Figure 6).

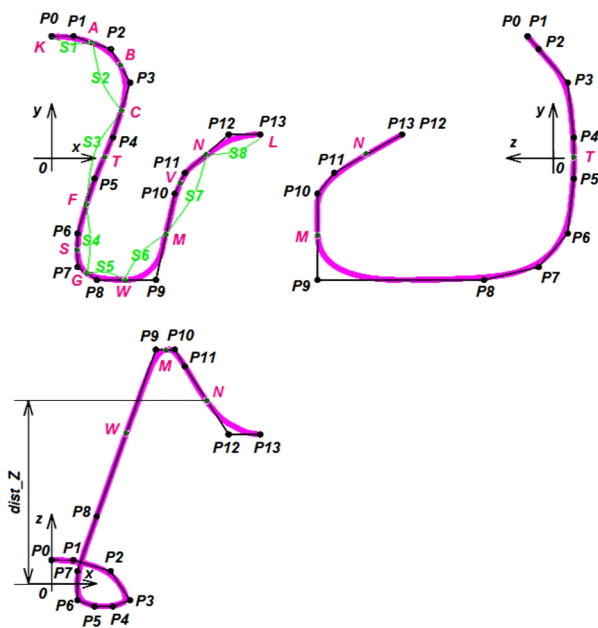
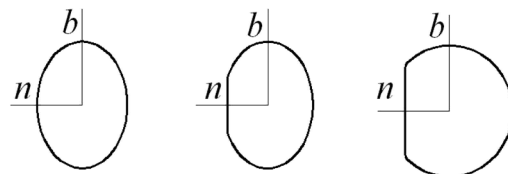

**Figure 6** Configuration of the filament axial line, representing half of a loop and half of a tuck (LC2)

A thread segment which represents half of a loop and half of a tuck can be divided into 8 separate segments ( $S_1 - S_8$ ) according to the curvature changes pattern. When considering the projection of half of the thread section in a double-layered weft knitted structures on the XOY, YOZ and XOZ planes (Figure 6), we observe that the areas S1, S5, S6, S8 don't contain bending points, and the areas S2, S3, S4 contain one, in which the curvature changes sign turns to the opposite. In this case the number of reference points, needed to describe a half of a loop and half of a tuck, is  $N=14$  ( $P0 - P13$ ).

## 5 YARN CROSS-SECTION SHAPE

One of the crucial points in creating a 3D model in knitted fabric is to set a shape and size of its cross-section in characteristic points of a loop. Independently of the yarn structure detalization, it is possible to formulate the basic features of its cross-section contouring. By definition, the cross-sectional plane of the yarn or thread passing through a given point of its central line is perpendicular to the tangent at this point. Due to the interaction between the mutually interlacing yarn segments, shape of their cross-sections changes, the compression area stay located in the cross-section segment that contains the main normal built to the curve at this point [29]. Then in the models that are using ellipses, circles and ellipses with a flat contact surface as the contour of the cross-section, normal and bi-normal lines can be arranged, as shown in Figure 7.



**Figure 7** Cross section of yarns, models of which are built without their structural elements displaying

Investigating the link between physic-mechanical properties of a yarn and a cross-section shape is yet another topic which will be studied upon further research.

## 6 EXPERIMENTAL DATA

During experimental research the plain structure samples made of different raw materials were studied. Basic characteristics of real knitted fabric have been tested under standard conditions and using standard methods of testing. Samples made of 4 yarn types with different loop length ( $L$  [mm]), flexlife and pilosity were studied. For each sample a 3D model with equal geometric parameters was built up. The values of the variable  $\gamma$  ensure a model to be constructed according to the requirements mentioned above (Table 2).



**Table 2** Angle  $\gamma$  values for the studied yarn types

Yarn type	№	Loop length of a real fabric [mm]	Values of the angle $\gamma$ which gives the coincidence of the loop length
Cotton yarn 30x2 tex	1.1	5.1	38
	1.2	5.5	33
	1.3	5.9	32
	1.4	6.3	24
	1.5	6.7	19
Viscose thread 28x2 tex	2.1	5.2	16
	2.2	5.7	12
	2.3	6.2	9
	2.4	6.7	5
	2.5	7.2	2
Wool-mixed yarn 31x2 tex	3.1	5.1	45
	3.2	5.5	40
	3.3	5.9	35
	3.4	6.3	30
	3.5	6.7	25
Wool yarn 31x2 tex	4.1	5.2	37
	4.2	5.7	35
	4.3	6.2	18
	4.4	6.7	16
	4.5	7.2	6
UHMWPE fiber 66 tex	5.1	4.0	36
	5.2	4.4	31
	5.3	4.8	29
	5.4	5.2	20
	5.5	5.6	16

## 7 RESULTS AND DISCUSSION

The task of predicting of the special purposes knitted fabrics properties might be solved by constructing a 3D geometric model of the knitwear structure. 3D geometric modeling of the knitted fabrics structure requires an exact display of the configuration of the axial line of the yarn in its structural elements [28, 29]. To describe the configuration of the yarn central line in the loop of the weft-knitting the authors have used the mathematic theory of B-spline construction. In the model, the length of the spatial curve varies with the change of the inclination angle of the tangent at the interlacing point as an independent variable. This makes the model flexible and feasible for use in 3D modeling systems where the loop length of the virtual knit pattern must coincide with the loop length of the real prototype. The suggested technique is realized at constructing a 3D model of the structure of double-layer knitwear made of ultra-strong polyethylene threads. We have generated the models of the knitted fabrics structures by using software which was developed by us [27].

It should be noted that 3D models of a double-layered knitted fabrics, constructed by us for the study, were built by using experimental data and selection of construction parameters by analyzing parameters of real structure and observing the structure under a microscope. Results, that we have obtained at this point, help us better understand a framework of model designing and clarify a plan of further research. To develop a theoretical base of passing from such input data as topology

and thread properties to building a model, a set of additional experiments is required, as a mechanism of threads mutual impact has not yet been studied.

Figures 8 and 9 show an image of a virtual sample of a plain-knitted structure fragment and a 3D structure of a double-layer knit with tuck connection of layers built by the means of this program [27].

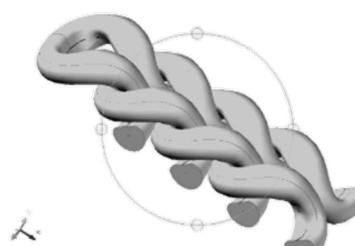

**Figure 8** 3D geometric model of a plain-knitted structure

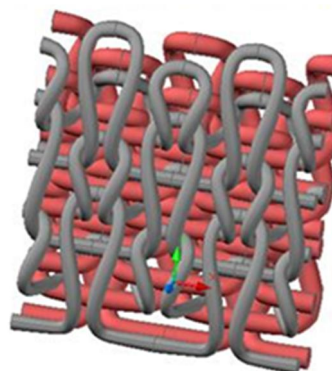

**Figure 9** 3D geometric model of a weft double-layer knit with tuck connection of layers

There are broad perspectives of using such models for assessing protective properties of the special purpose knitwear. The double-layered knitwear structure with polyethylene threads is used for manufacturing a wide range of protective clothing, including clothing with ballistic protection. Unfortunately, the evaluation of knitted fabric ballistic resistance to impact from different weapon types can hardly be tested under real-life conditions.

When designing special purpose knitwear, for instance for fencing clothing manufacturing, virtual models allow us to predict its pressure bearing capacity against multiple impact points caused by a tip of a fencing weapon. It gives us opportunities to visualize the hits of the blade tip on the loops and predict their deformation and as a result to design an optimal knitwear structure with the specified physic-mechanical properties [31].

During experimental research we produced the weft knit structure samples made of different raw materials and studied their structure parameters. For each sample we designed a 3D model with geometric parameters that coincide with the real prototype parameters. We defined the angle values at tangent point of a fabric for each sample. Changing of an independent angular parameter value used as an independent variable  $\gamma$ , allows getting a spatial curve of a necessary length.

## 8 CONCLUSIONS

Three-dimensional geometric modeling and simulation of knitted fabric structures requires accurate reflection of the yarn axial line configuration in its structure elements. For configuration description of the yarn central line in a loop of weft-knitted structure, mathematical basis of B-spline can be applied. The developed method of calculation of control vertices for B-spline definition coordinates, using the basic knitted structure parameters is worked out for building a 3D double-layered knitwear structure manufactured with the use of ultra-high-molecular-weight polyethylene fiber (UHMWPE). Changing of an independent angular parameter value used as an independent variable  $\gamma$ , allows getting a spatial curve of a necessary length.

The results of the conducted research have concluded the high level of conformity of the 3D model, namely, by the parameters of the loop length, course spacing and wale spacing the real parameters of its structure.

Further researches will focus on defining the relation between the independent variable  $\gamma$  and yarn physic-mechanical properties which will allow using the developed technique for predicting the stability of knitwear to various dynamic loads without need for making a sample on knitting equipment.

## 9 REFERENCES

1. Chistyakov E.: Armour materials based on polymeric fibers, *Peace and Security* 4, 2014, pp.19-25 (in Russian)
2. Bobrova S., Halavska L.: Ballistic knitted fabrics development for body armor production, *Bulletin of Kiev National University of Technology and Design* 2015, 3(86): A series of "Engineering", pp.114-120 (in Ukrainian), [http://er.knutd.com.ua/bitstream/123456789/474/1/V86\\_P133-140.pdf](http://er.knutd.com.ua/bitstream/123456789/474/1/V86_P133-140.pdf)
3. Tompkins E.: *The Science of Knitting*, London, New York: John Wiley and Sons, 1914, p. 330
4. Chamberlain J.: *Hosiery yarn and fabrics*, Vol.1, Leicester: City of Leicester Technical College, 1926
5. Pierce F.T.: Geometrical principles applicable to the design of functional fabrics, *Textile Research Journal* 17(3), 1947, pp. 123-147, doi: 10.1177/004051754701700301
6. Glaskin A., Leaf G.A.V.: An analysis of the stresses in some approximation to a simple knitted loop of monofilament yarn, *Journal of the Textile Institute Transactions* 44(11), 1953, pp. 534-543, doi: 10.1080/19447025308662615
7. Munden D.L.: The geometry and dimensional properties of plain-knit fabrics, *Journal of the Textile Institute Transactions* 50(7), 1959, pp. 448-471, doi: 10.1080/19447025908659923
8. Vékássy A.: Examination of the cover-factor and specific weight of weft-knitted or looped basis texture based on the exact value of the loop length, *Acta Technica* 31, 1960, pp. 69-102
9. Dalidovich A.: *The fundamentals of knitting theory*, Moscow, 1970, p. 432 (in Russian)
10. Korlinski W.: Theoretical and empirical generalized model of plain knit goods, *Melliand Textilberichte* 10, 1985
11. Morooka H., Matsumoto Y.: A geometric analysis of the stitch form of a circular plain knit fabric inserted over a cylinder, *Textile Research Journal* 68(12), 1998, pp. 930-936, doi: 10.1177/004051759806801208
12. Krutikova V.: Development of the theory of knitwear formation and methods for predicting the technological parameters of the knitting process on flat and circular knitting machines.; Dissertation for a Doctor degree of technical sciences, Kostroma, 2007 (in Russian)
13. Nutting, T.S., Leaf G.: A generalized geometry of weft-knitted fabrics, *Journal of the Textile Institute* 55(1), 1964, pp. 45-53, doi: 10.1080/19447026408660207
14. Postle R.: *The mechanics of the relaxed plain-knitted structure*, Ph.D. thesis, Leeds University, 1965
15. Whitney J.M., Epting J.L.: Three-dimensional analysis of a plain knitted fabric subjected to biaxial stresses, *Textile Research Journal* 36(2), 1966, pp. 143-147, doi: 10.1177/004051756603600207
16. Popper P.: The theoretical behavior of a knitted fabric subjected to biaxial stresses, *Textile Research Journal* 36(2), 1966, pp. 148-157, doi: 10.1177/004051756603600208

17. Postle R., Munden D.L.: Analysis of the dry-relaxed knitted-loop configuration: Part 1: Two-dimensional analysis, *Journal of the Textile Institute* 58(8), 1967, pp. 329-351, doi: 10.1080/00405006708629880
18. Shanahan W.J., Postle R.: A Theoretical analysis of the plain-knitted structure, *Textile Research Journal* 40(7), 1970, pp. 656-665, doi: 10.1177/004051757004000712
19. Hepworth B., Hepworth K., Leaf G.A.V.: The plain knitted structure, *Textile Research Journal* 40, 1970, p. 863
20. Truevtsev A.: Applied knitting mechanics: the handbook, St. Petersburg, 2001, p. 87 (in Russian)
21. Kurbak A., Ekmen O.: Basic studies for modeling complex weft knitted fabric structures, Part I: a geometrical model for widthwise curlings of plain knitted fabrics, *Textile Research Journal* 78(3), 2008, pp. 198-208, doi: 10.1177/0040517507082352
22. Demiroz A., Dias T.: A study of the graphical representation of plain-knitted structures, Part I: stitch model for the graphical representation of plain-knitted structures, *Journal the Textile Institute* 91(4), 2000, pp. 463-480, doi: 10.1080/00405000008659121
23. Kyosev Y., Angelova Y., Kovar R.: 3D modeling of plain weft knitted structures of compressible yarn, *Research Journal of Textile and Apparel* 9(1), 2005, pp. 88-97, doi: 10.1108/RJTA-09-01-2005-B009
24. Li Yinglin, Yang Lianhe, Chen Suying, Xu Lei: Three dimensional simulation of weft knitted fabric based on surface model, *Computer modeling & new technologies* 18(3), 2014, pp. 52-57
25. Y.Kyosev: Geometrical and mechanical modelling of textile structures at fiber and yarn level – software and data structures, *Vlakna a Textil (Fibres and Textiles)* 24(1), 2017, pp. 3-9
26. Ielina T.: Improvement of design of the weft knitted fabric by the three-dimensional geometric modeling of its structure, Dissertation for a candidate degree of technical sciences, Kyiv National University of Technologies and Design, Kyiv, 2013 (in Ukrainian)
27. A.S.46469 Ukraine. Computer program «Structura – 3D». Ielina T.V., Galavska L. 46726 from 25.09.2012, published 23.11.2012 (in Ukrainian)
28. Ielina T.: Research of compliance of the developed three-dimensional geometric model of a loop of weft-knitted jersey to its real configuration, *Bulletin of Kiev National University of Technology and Design* 5(67), 2012, pp. 94-99 (in Ukrainian), [http://er.knutd.com.ua/bitstream/123456789/3299/1/V67\\_P094-099.pdf](http://er.knutd.com.ua/bitstream/123456789/3299/1/V67_P094-099.pdf)
29. Ausheva N., Galavska L., Ielina T.: Geometric representations features of textile yarn in the 3d modeling systems, International Scientific Conference UNITECH-13, 22-23 November 2013, Gabrovo, Bulgaria, vol. III, pp.199-202
30. Halavska L.: Development of scientific bases of integrated knitted fabric manufacture of a functional purpose with the set properties, Dissertation for a Doctor degree of technical sciences, Kyiv National University of Technologies and Design, Kyiv, 2013 (in Ukrainian)
31. Beskin N., Halavska L.: Research of knit for fencing suits on resistance against perforation, Book of abstracts of 47<sup>th</sup> International Federation of Knitting Technologists Congress, 25-26 September 2014. Izmir, Turkey, pp.42-43